

Gridded Surface Subsurface Hydrologic Analysis (GSSHA)

Introduction



What is GSSHA?

- GSSHA is a complete watershed simulation and management model used for hydrologic, hydraulic, sediment and quality simulation and management.
- GSSHA is a fully distributed, physics based model that utilizes a grid to represent the watershed.
- GSSHA is a product of the US Army ERDC
 - Maintained
 - Supported
 - Distributed
- GSSHA is a direct descendent of the surface water hydrologic model CASC2D developed at Colorado State University.
- The original version of GSSHA is the result of Chuck's dissertation work at University of Connecticut.

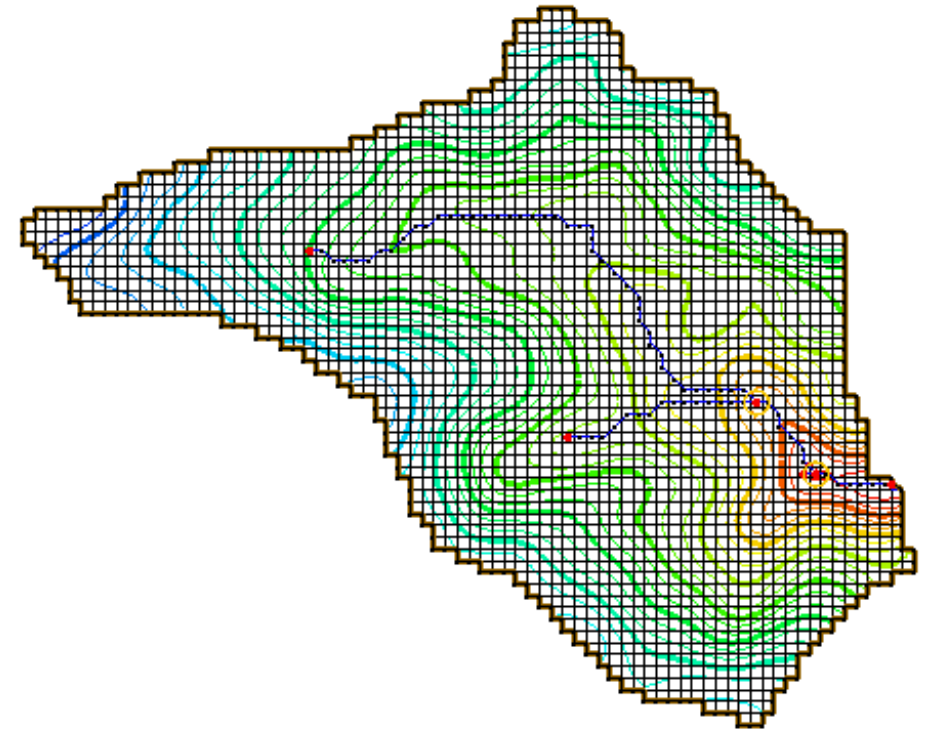

Downer, C. W. *Identification and Modeling of Important Stream Flow Producing Processes in Watersheds*, PhD Dissertation, University of Connecticut, 2002.

How does GSSHA Work?

- GSSHA works on a uniform spatial grid.
- Basic equations of mass, energy, and momentum conservation are solved with finite volume and finite difference techniques.
- Point processes are solved at the grid level.
- Point responses are integrated to get the system response.

Cascading planes
in two dimensions –
CASC2D

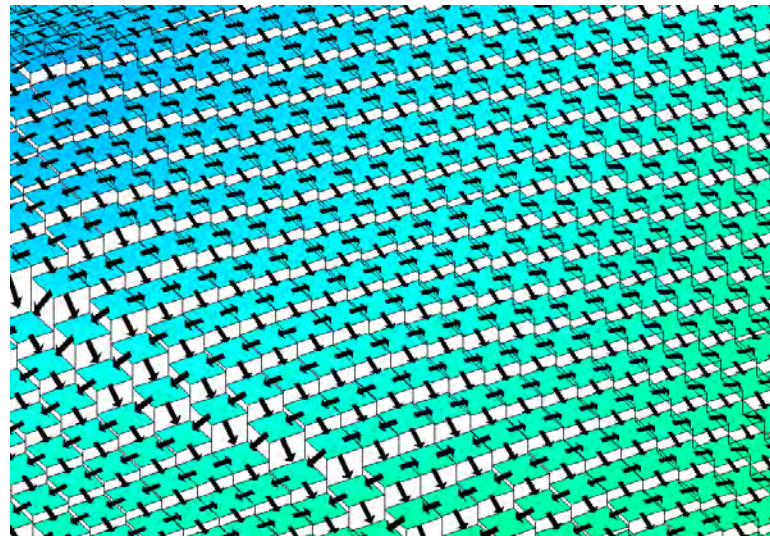
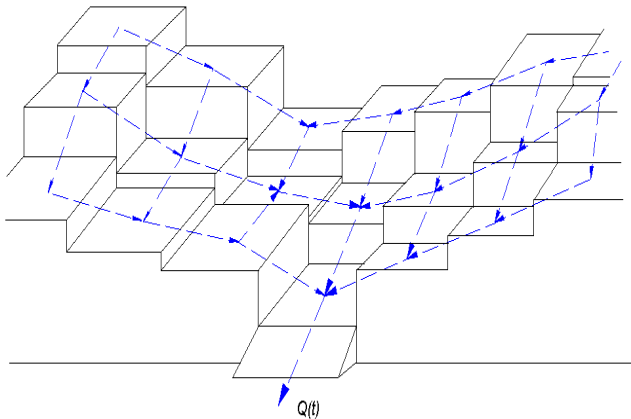

Computational Grid

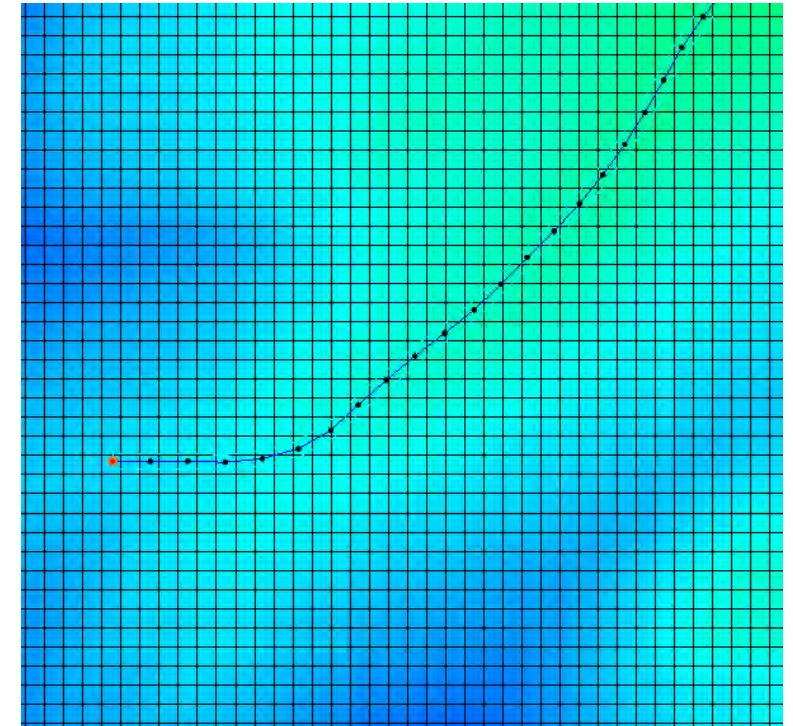

Why Does This Matter?

- Spatial variability.
- Physically based parameters.

More Accurate Model Results

Allows for better representation of future alternatives

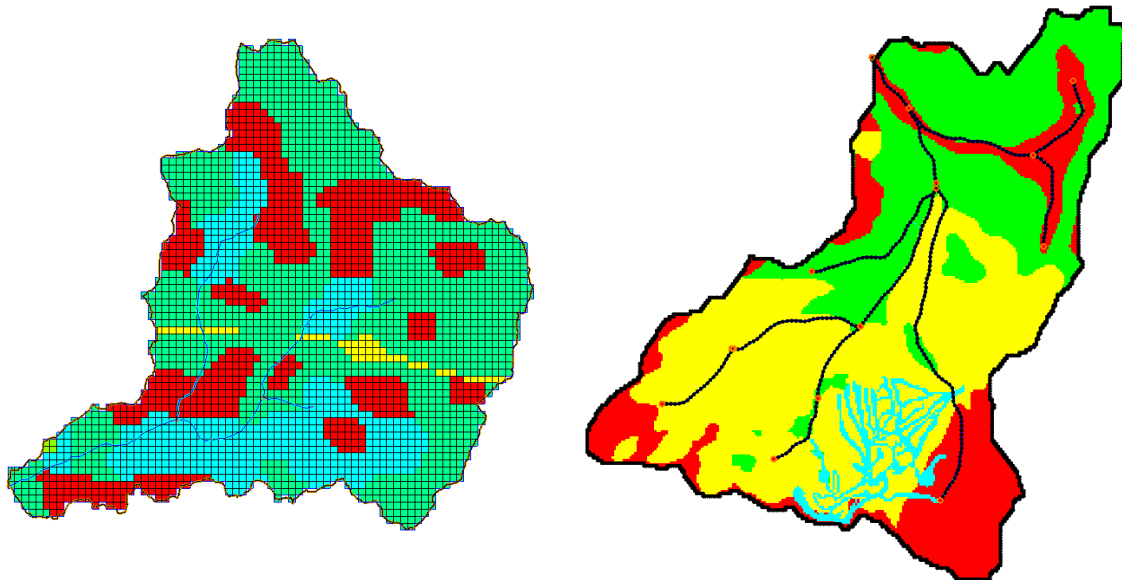

Spatial Variability

- Explicitly include spatially heterogeneous features, such as varying land use, source areas, BMPs, etc.

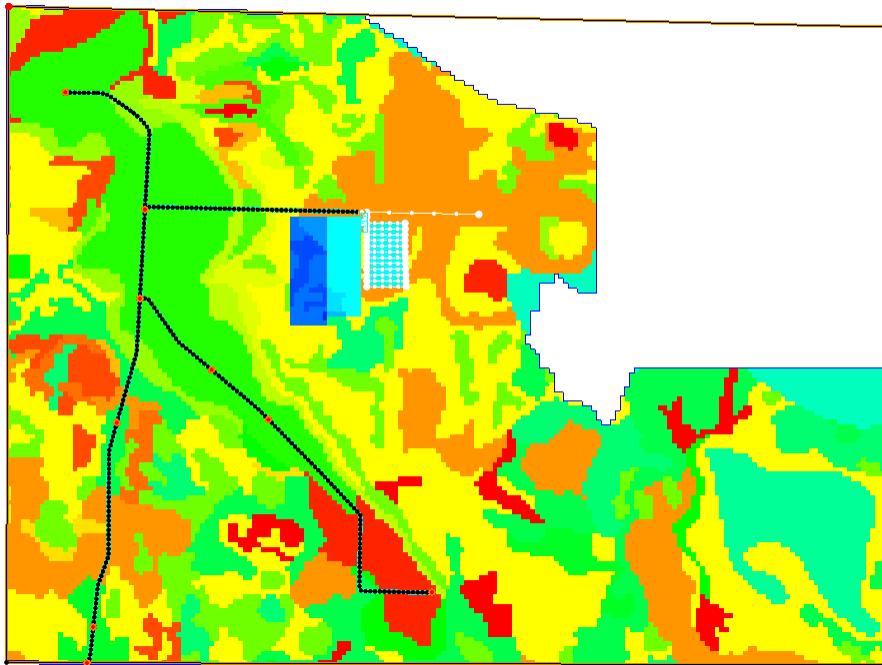

Physically Based Parameters

- Values are based on physical conditions in the computational element.
 - requires less calibration data
 - extendible beyond calibration range
- The tie to physical conditions provides a means to logically alter parameters based on changing conditions.
 - land use changes
 - project alternatives
 - climate change





Surface water hydrology



Surface Water/Groundwater
Interaction

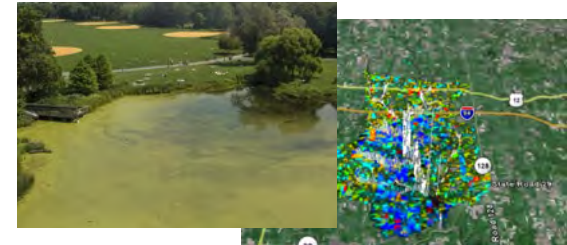

Surface water quality and
TMDL's

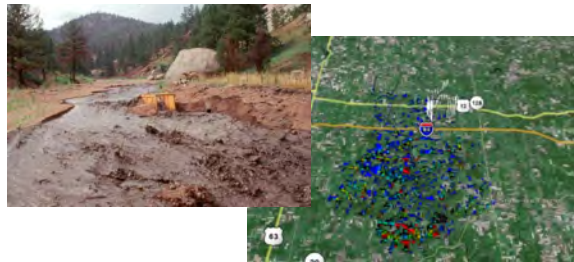

Sediment Management

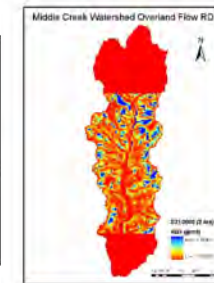
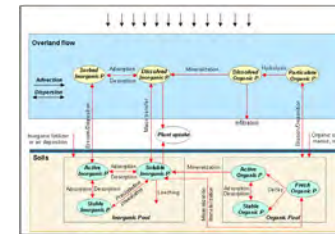

Contaminant fate/transport in
surface water and
groundwater and related
health risk assessment

Watershed Modeling and Management

GSSHA Simulation Capabilities



$$\frac{\partial h}{\partial t} = \frac{\partial \bar{q}}{\partial x} + \frac{\partial \bar{q}}{\partial y}$$

$$\bar{q} = \frac{1}{n} d^{5/3} S_{fx}^{1/2} \vec{i} + \frac{1}{n} d^{5/3} S_{fy}^{1/2} \vec{j}$$

$$S_{fx} = S_{ox} - \frac{dh}{dx}; S_{fy} = S_{oy} - \frac{dh}{dy}$$

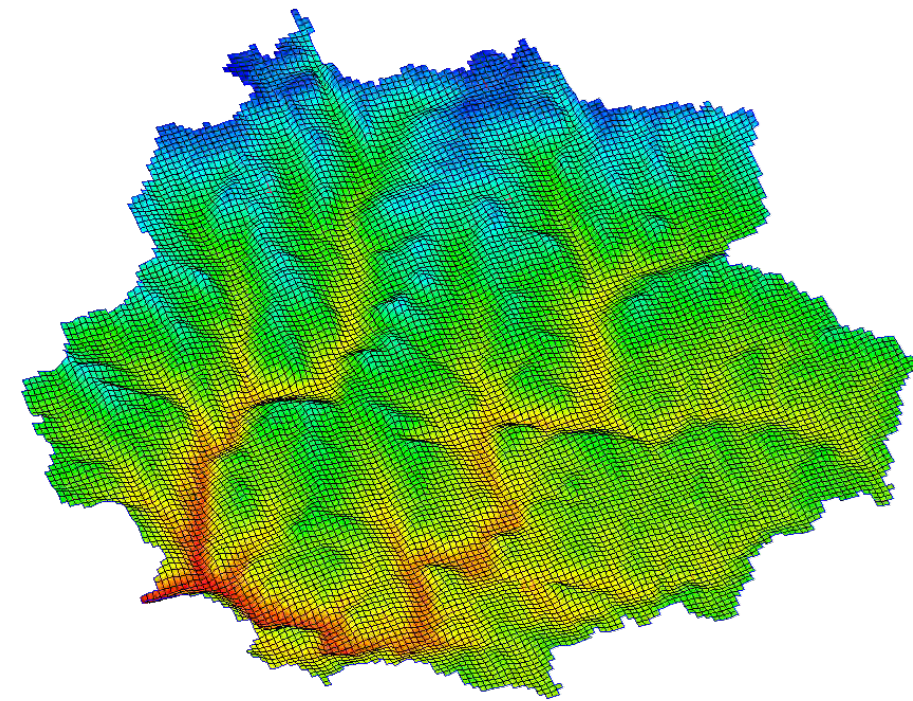

*Allows for backwater affects and
overland/channel interactions!*

1D Stream Network

$$Q_{i-1/2} = \frac{1}{n} A_{i-1} R_{i-1}^{2/3} S_{f_{i-1/2}}^{1/2}$$

$$\frac{\partial h}{\partial x} = S_o - S_f$$

$$\frac{\partial A}{\partial t} + \frac{\partial Q}{\partial x} = S$$

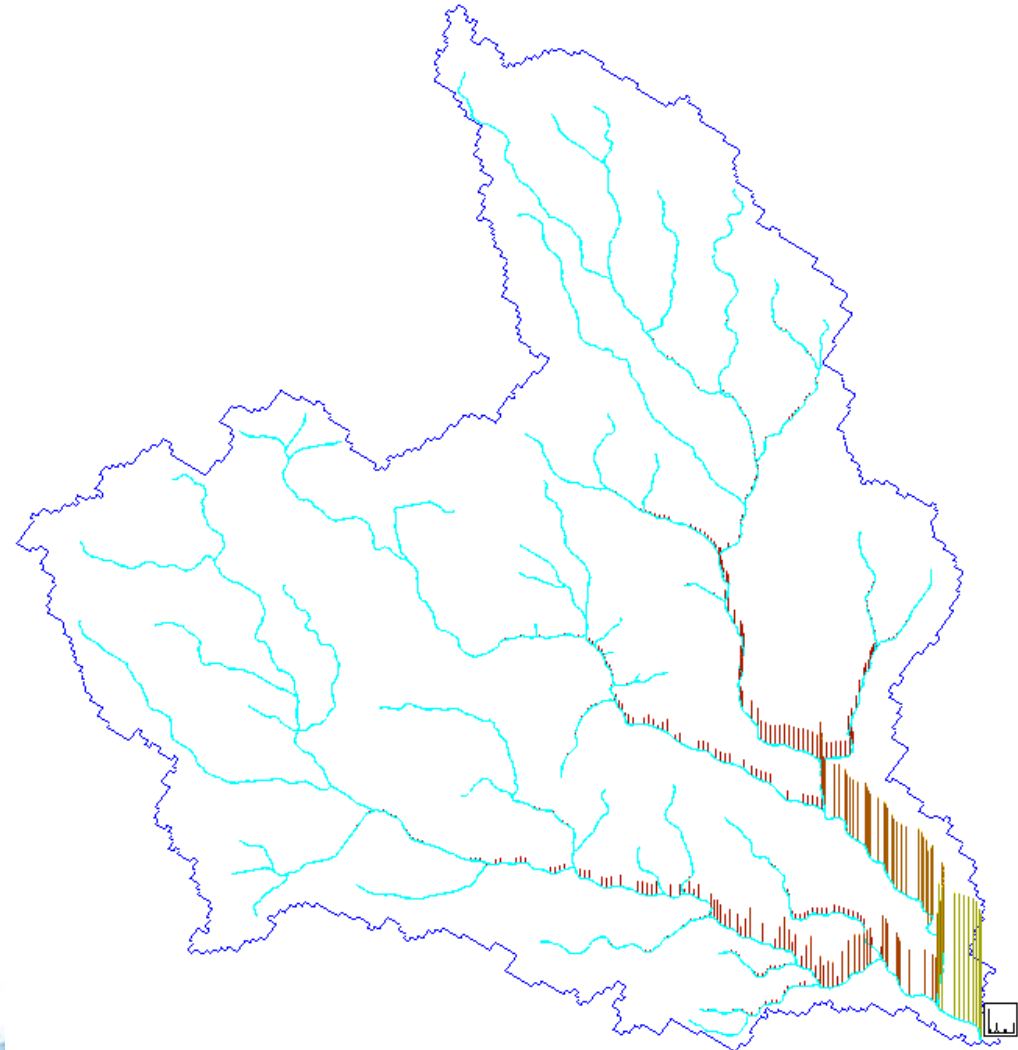

Infiltration and Evapotranspiration

- Infiltration
 - Richards Equation
 - 3 primary soil layers
 - infinite subdivisions of each layer
 - Green and Ampt, 1 layer
 - Two-layer Green and Ampt w/ Soil Moisture Redistribution
 - Three-layer Green and Ampt model with soil moisture accounting
- Evapotranspiration
 - Deardorff bare earth
 - Penman – Montieith



- GSSHA has the capability to perform continuous simulations for unlimited periods of time.
 - Soil moisture modeling between events.
 - Model provides the initial conditions for each episodic event.
 - This is critical for determining verifiable parameter sets (Senarath et. al, 2000).

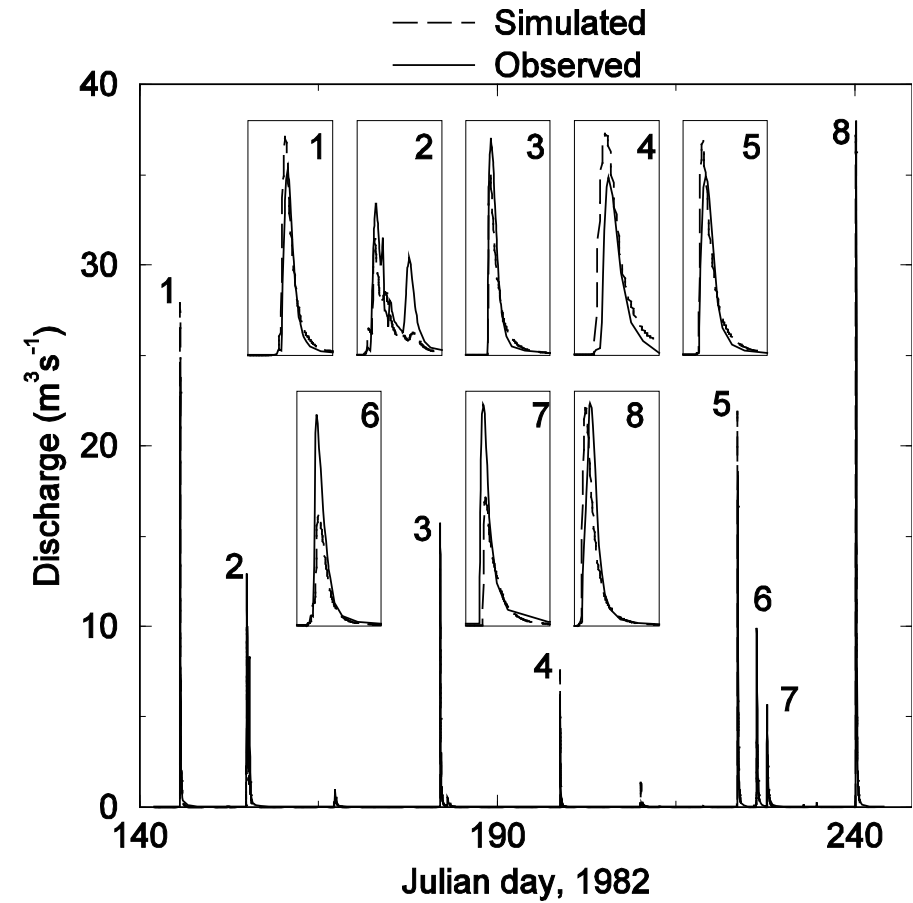

Spatially Explicit Soil Moisture Evolution

Soil moisture over multiple
rainfall cycles depends factors
including

- Rainfall
- ET
- Soil
- Landuse
- Location of water table

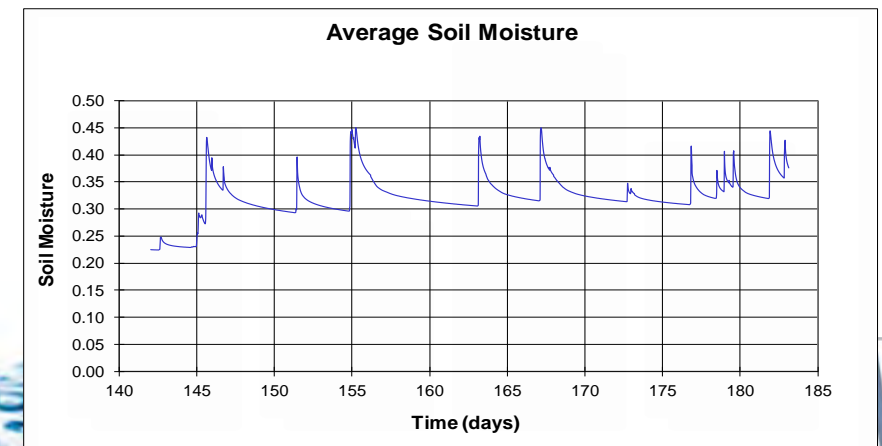

Snow Accumulation and Melt

- Modeling of Snow Water Equivalent (SWE)
 - Three Snow Accumulation / Melt Methods
 - Energy Balance Method
 - Temperature-Index Method
 - Hybrid Energy Balance Method
 - Accounting for Snow Pack Dynamics
- Adjustments to HMET Forcing Data
- Melt Water Transport
 - Vertical Flow through Snow Pack
 - Lateral Flow through Snow Pack
 - Frozen Ground to Impede Infiltration



Snow Accumulation and Melt

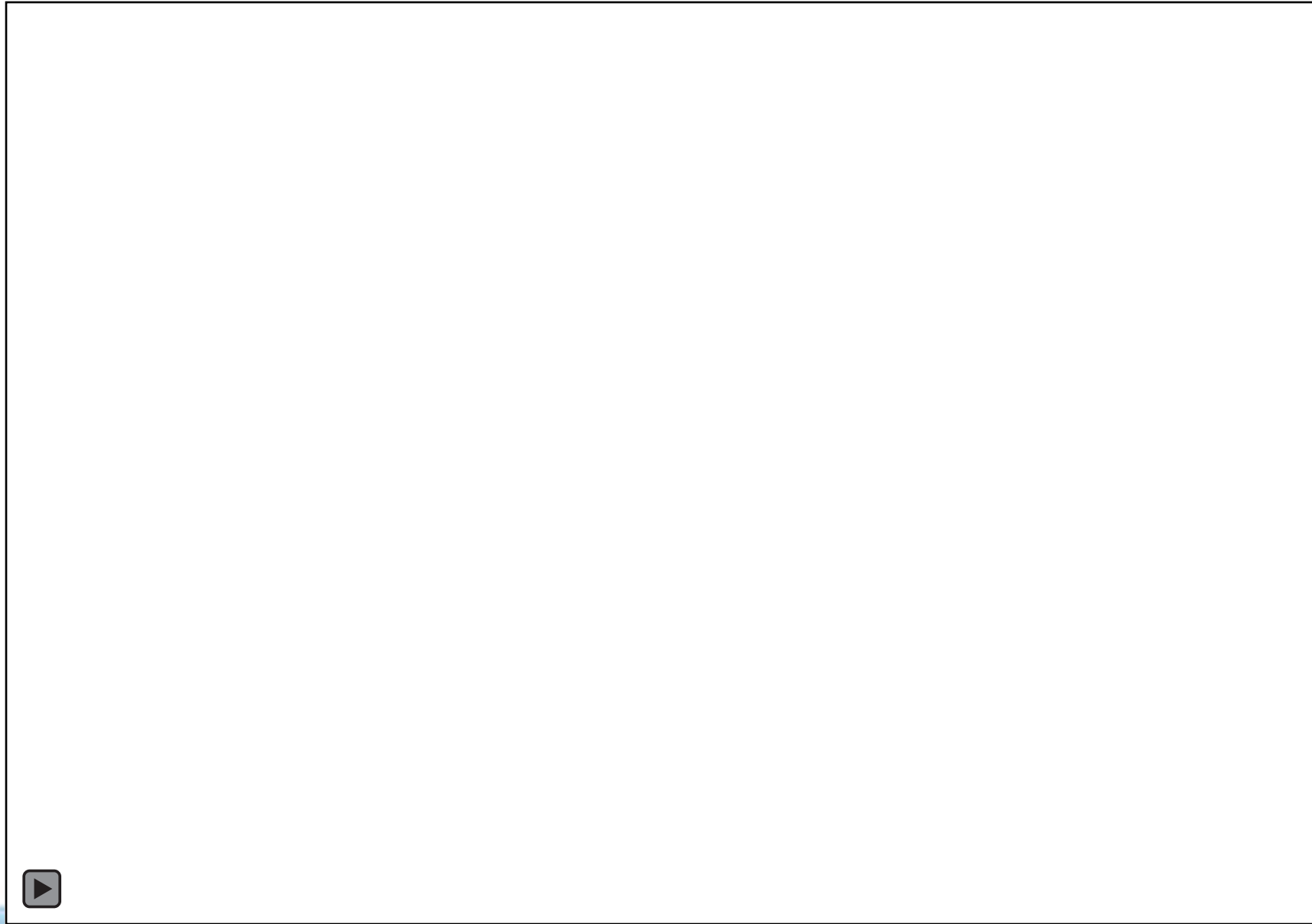

- Can be added to your 1D stream network
- Types
 - Broad crested weirs
 - Horizontal
 - Parabolic
 - Culverts
 - Circular
 - Rectangular
 - Active control structures
 - Rule curve
 - Scheduled discharge
 - Generic structure rating curve
- Reservoirs or detention basins can also be added to your network.



$$\frac{\partial}{\partial x} \left(K_{xx} b \frac{\partial E_{ws}}{\partial x} \right) + \frac{\partial}{\partial y} \left(K_{yy} b \frac{\partial E_{ws}}{\partial y} \right) = S \frac{\partial E_{ws}}{\partial t} + W(x, y, t)$$

- Single-layer free surface groundwater equation
- Provides recharge -> groundwater flow
-> stream, seep interaction
- Allows for environmentally important flows (low flows, wetlands) to be modeled
- Important for modeling saturation excess runoff



Surface Water Groundwater Interaction

- Surface water models can only represent the fast response of the watershed, runoff due to infiltration excess (with deep depth-to-groundwater).
- Groundwater models can only represent the slow response of the watershed, due to stream graining and losing from/to groundwater.
- Shallow depth-to-groundwater is needed for saturation excess runoff
- All responses are required to simulate watershed responses in complex watersheds with mixed runoff.
- GSSHA is specifically formulated to solve this complex problem.

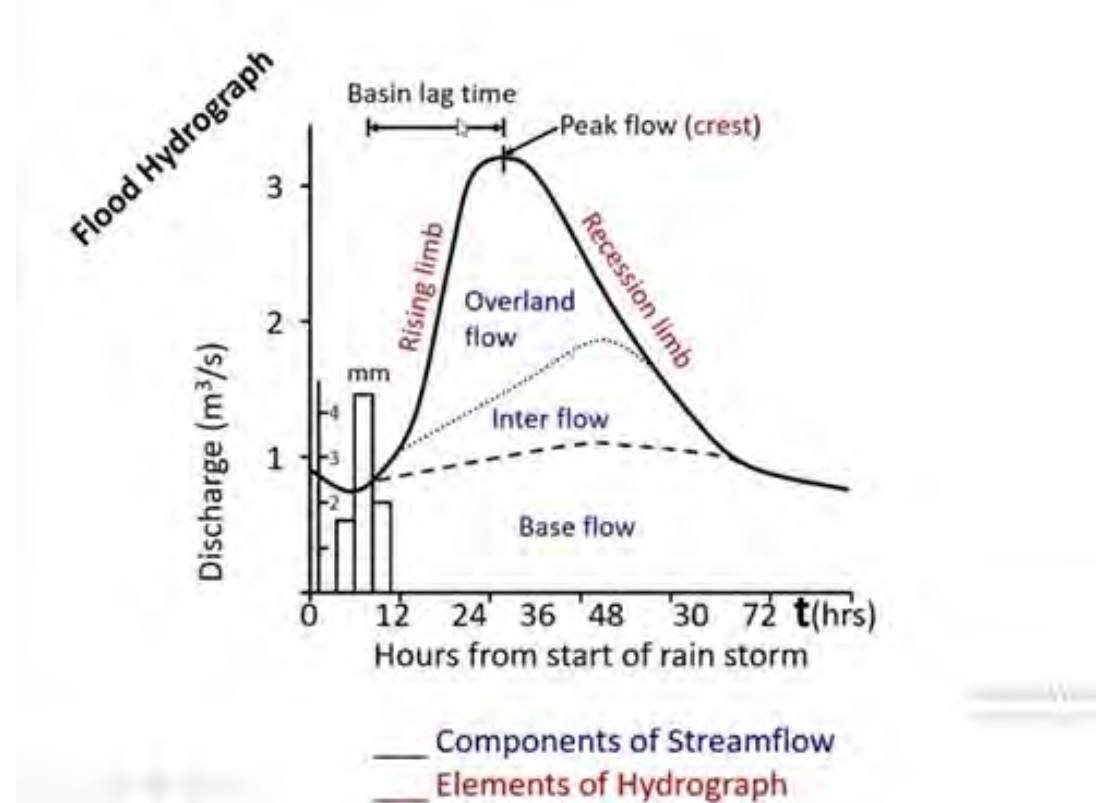

Storm and Tile Drains

- Connected set of pipes, manholes, inlet grates
- Tile drains are porous pipes that drain groundwater in agricultural areas.

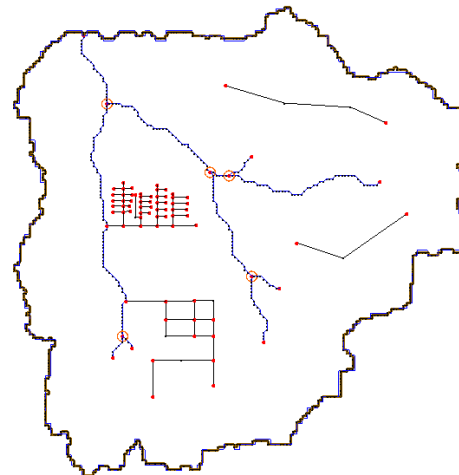
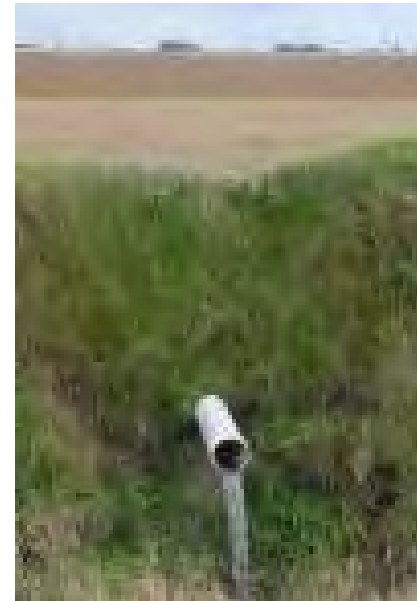
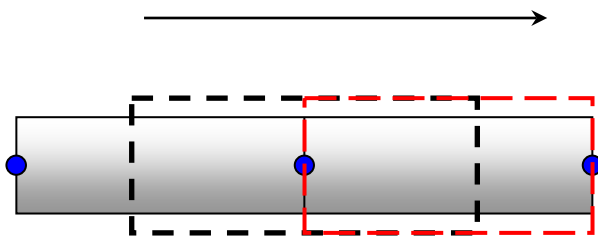
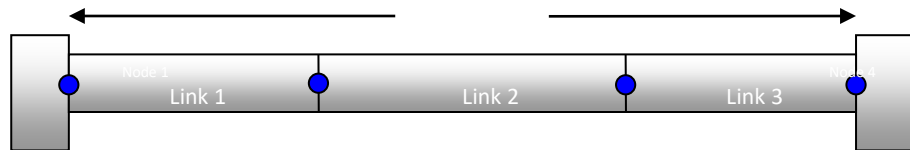

- Event based erosion and deposition model (not USLE-based)
 - Overland
 - Streams
- User-defined sediment properties



Erosion/Deposition

- Low/Low
- Low/High
- High/Low
- High/High

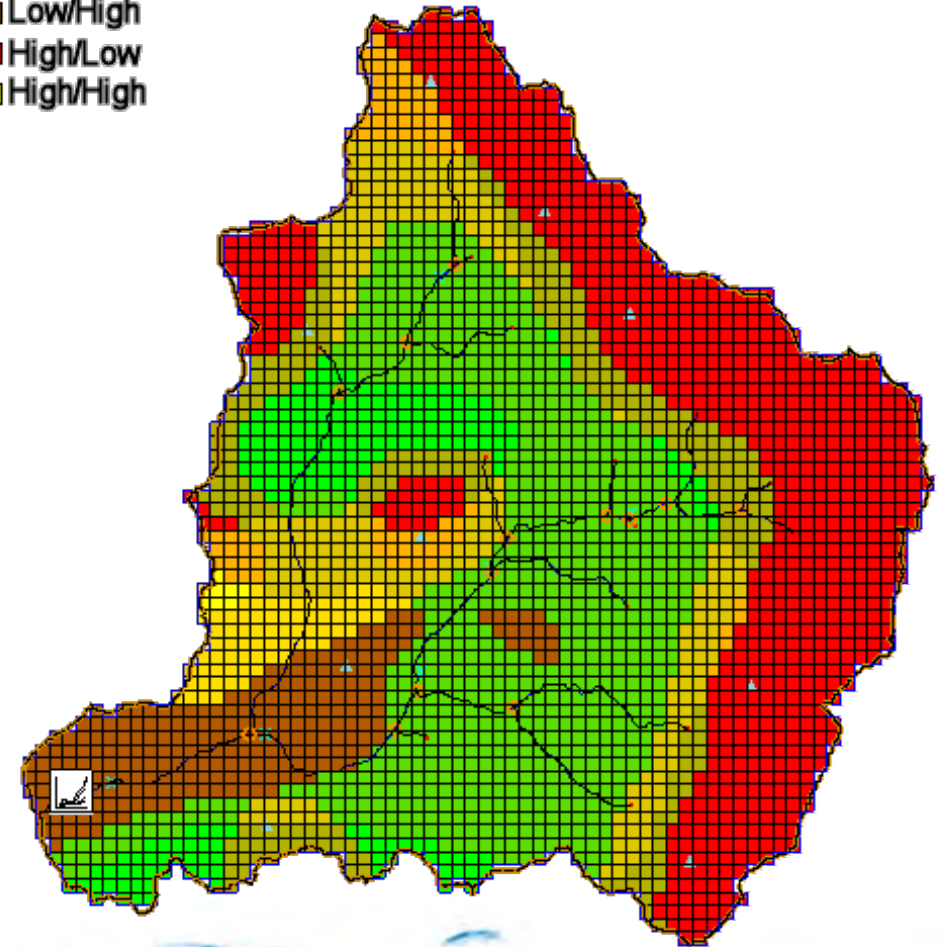

- GSSHA has the capability to simulate constituent fate and transport in surface water components of the model.
 - Soil column
 - Overland
 - Streams
- Kinetics
 - First order
- Dissolved and sorbed phases

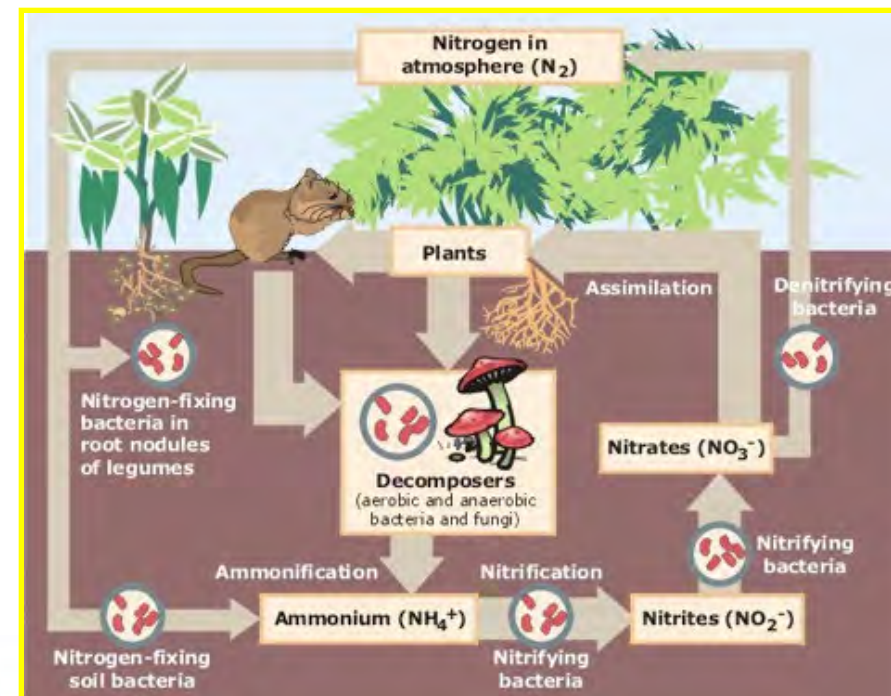

Clear Water 1D/2D (Under Development)

Nutrients

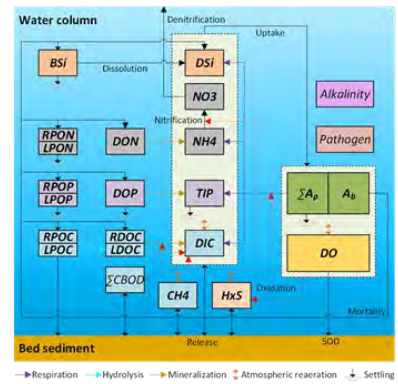

Radionuclides

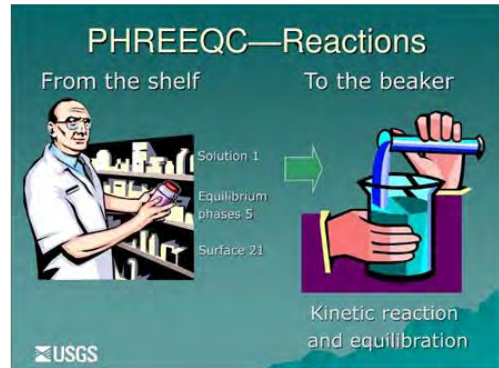

Water Temperature

$$\frac{dT_i}{dt} = \frac{Q_{i-1} T_{i-1}}{V_i} - \frac{Q_i T_i}{V_i} + \frac{Q_{out,i}}{V_i} T_i + \frac{E_{i-1}}{V_i} (T_{i-1} - T_i) - \frac{E_i}{V_i} (T_{i+1} - T_i) + \frac{W_{b,i}}{\rho_w C_{pw} V_i} \left(\frac{m^3}{10^6 cm^3} \right) + \frac{J_{a,i}}{\rho_w C_{pw} H_i} \left(\frac{m}{100 cm} \right) + \frac{J_{s,i}}{\rho_w C_{pw} H_i} \left(\frac{m}{100 cm} \right)$$

- i = channel reach/overland grid cell
- i-1 = inflows into reach or cell
- i+1 = outflows from reach or cell
- Term 1: Inflows into reach or cell
- Term 2: Reach or Cell
- Term 3: Outflows from reach or cell
- Term 4: Dispersion into reach or cell
- Term 5: Dispersion out of reach or cell
- Term 6: Point and Non-Point Sources
- Term 7: Air-Water Heat Flux
- Term 8: Bed Layer/Soil-Water Heat Flux

Sediment Diagenesis

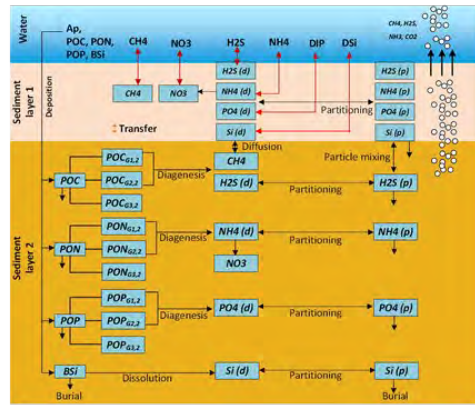

Contaminants

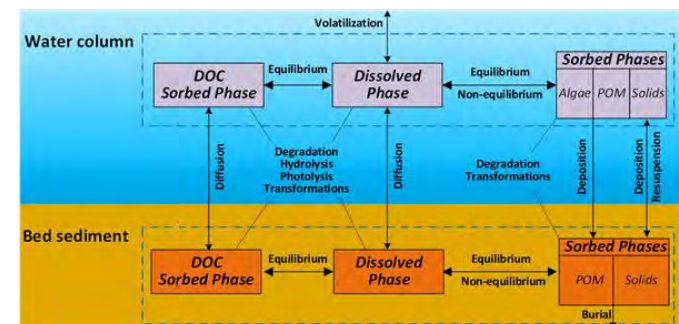

Mercury

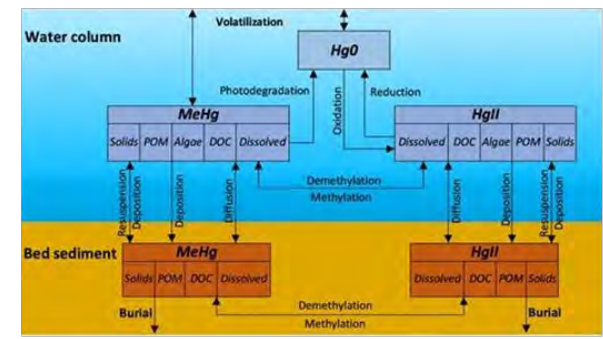

How Do I Build a GSSHA Model?

- GSSHA models are most easily built using the WMS software.
- Some files must be built with common text editors or spreadsheets. Additional utilities for building file types not supported by WMS are provided on the GSSHA wiki.
- Once the spatial aspects of the model have been assigned, simple changes to model input may be accomplished by directly editing the project and mapping table files.



How Do I Run GSSHA?

- GSSHA is run from the command line in a Windows Dialogue box.
- GSSHA can also be run from WMS, which basically calls up a Windows Dialogue box and launches GSSHA for you.
- GSSHA models work on the following platforms:
 - Windows
 - LINUX
 - Supercomputer



Why use GSSHA?

- Model floods, water balance, and ecological flows
 - Flexible processes selection tailored to watershed and project characteristics
- Integrated Process Modeling
 - Changes in one process affect other processes
 - Coupled groundwater, soil moisture, stream, and overland flow models
- Spatially explicit formulation: can evaluate impacts of *where* changes occur
 - Location of wetlands addition
 - Location of land use change
- Physical Process-driven model: can simulate fundamental changes in processes such as
 - tile drain removal,
 - addition of wetlands, and
 - changes in land use

Allows for more accurate and scientifically defensible model predictions due to changes in landuse, soil amendments, terrain, best management practices, and forcing functions!



Integrated Surface and Overland Modeling

- Stream channels are integrated with the overland and groundwater flow regimes.
- Allows water in 2D systems to enter/exit the stream channel at correct time and location.
- Reservoirs are simulated as both channel and overland features. Reservoirs can expand and contract in both the channels and on the overland flow plane.
- *Each physically simulated processes is allowed to interact with and be affected by the other physical processes. This allows for impacts and changes to be more realistically modeled.*





Dynamic Reservoir Simulation



Explicit Spatial Process Descriptions

- Spatially varied heterogeneity
- Explicitly resolve features in the grid
 - Land use
 - Soil type
 - Depressions
 - BMPs
 - Roads
 - Wetlands
- Track fate of water, sediment, contaminants along flow path
 - Infiltration along path
 - Settling/erosion along path
 - Reactions along path

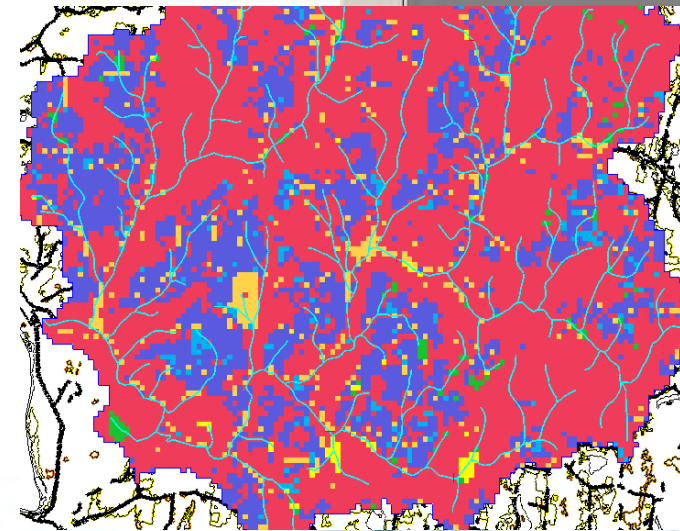
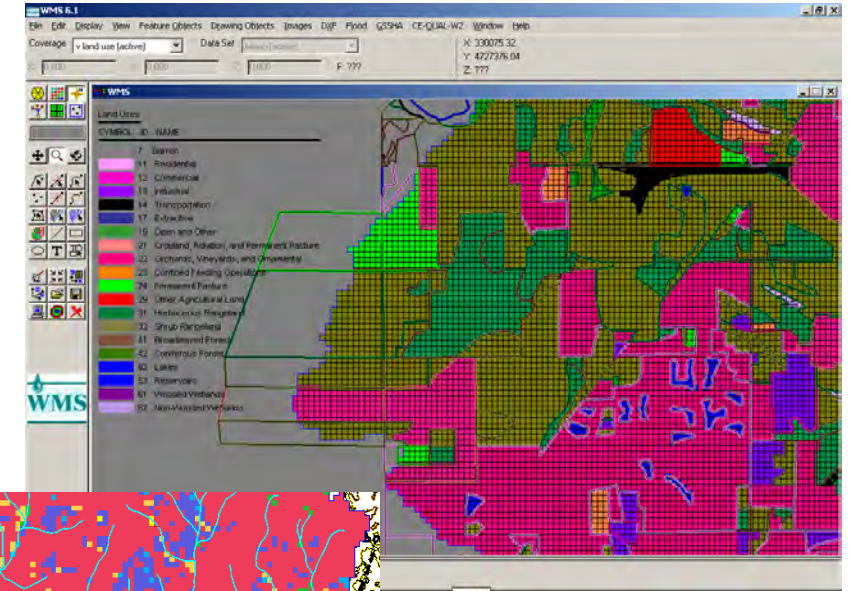

Modeling changes in physical processes

- Converting from tile drained fields to wetlands is a change in the fundamental runoff mechanisms
- GSSHA simulates the actual runoff processes in their spatial context
- By simulating the physical processes we are able to model changes to the watershed that include
 - Precipitation events outside the calibration range
 - Changes in fundamental runoff generation mechanisms
 - Changes in runoff transport mechanisms
 - Resulting impacts to nutrient and sediment production and transport



Urbanization and Wetlands Creation in the Kishwaukee Watershed

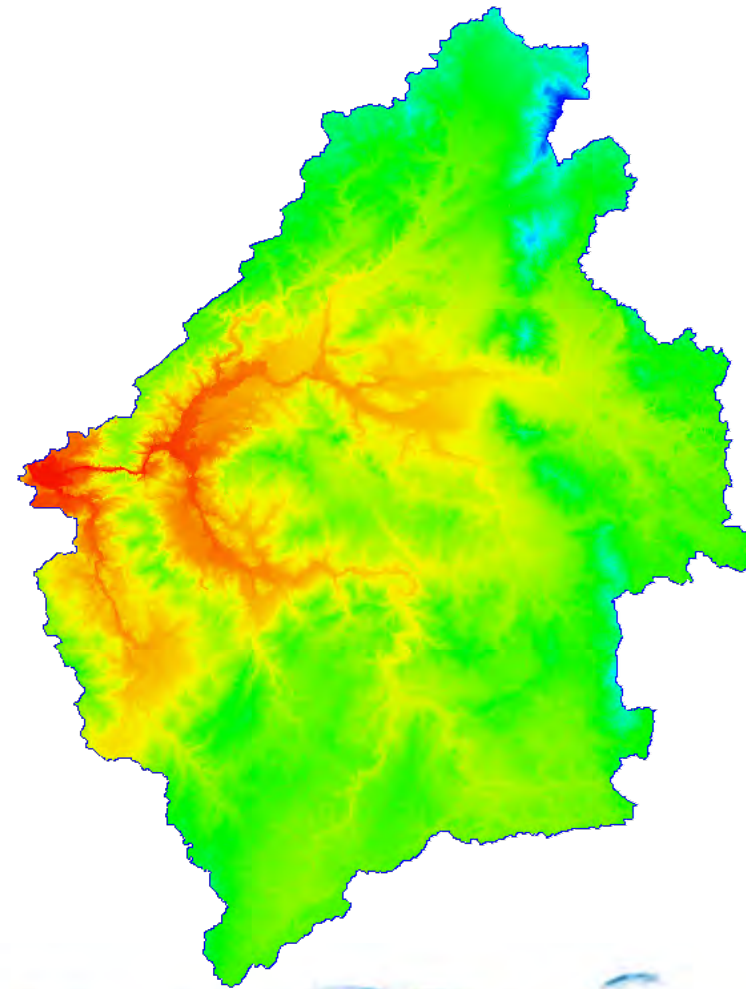
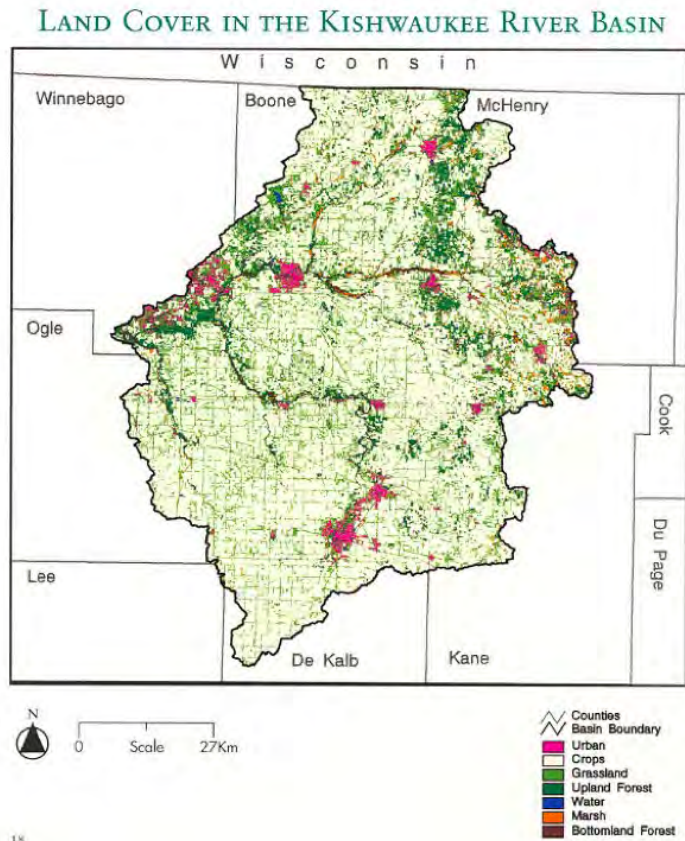

- Watershed Area:
~1100 mi²
- Stream Miles:
~1000 mi
- Overland flow
- Stream flow
- Infiltration
- Groundwater
- Tile Drains
- Detention Basin
- Wetland Hydraulics

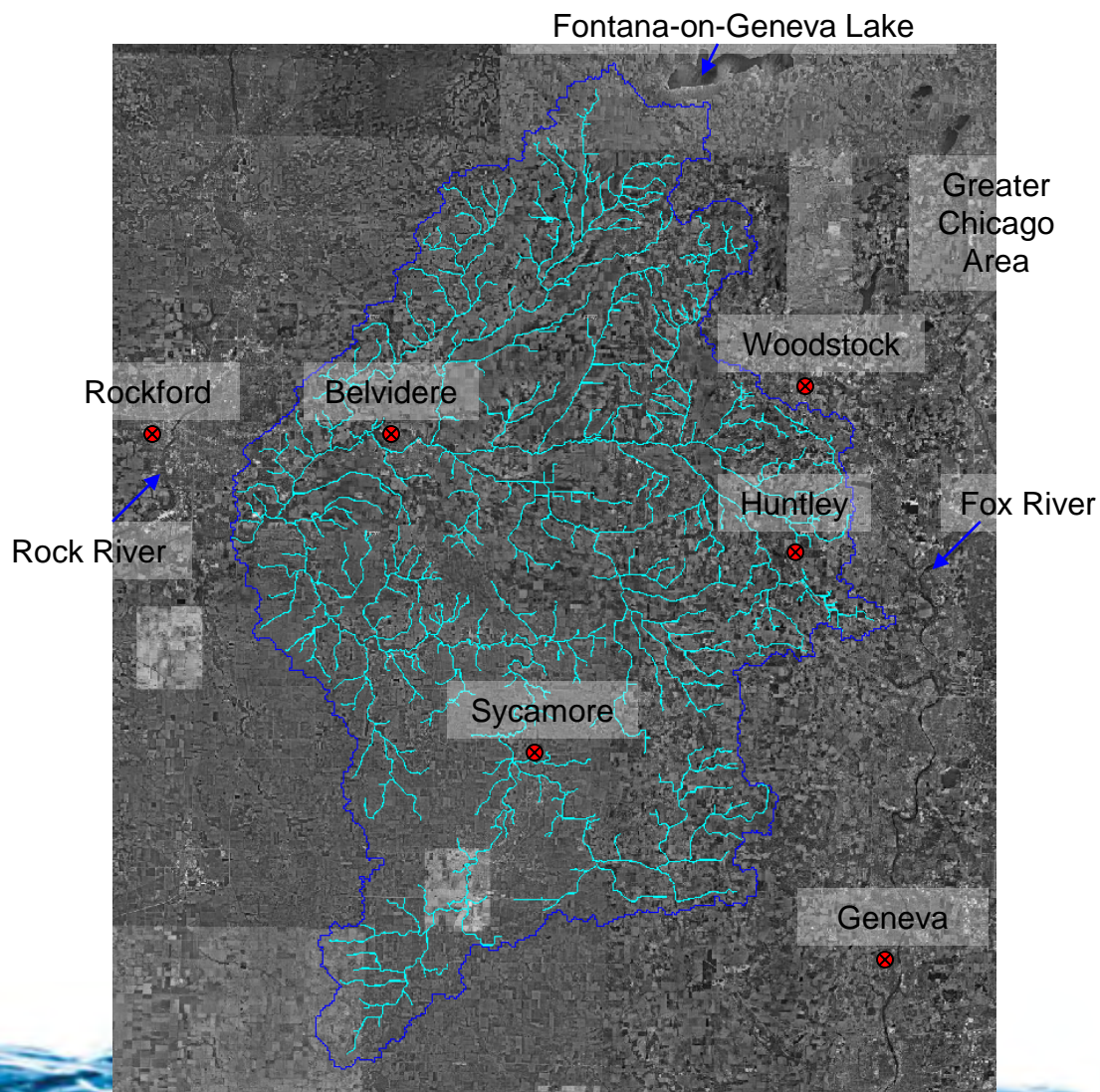

- Develop Watershed Management Plan
 - Placement of 1600 ac of wetlands
 - Removal of tile drains
 - Assess impacts of future land use



Impacts of Spatial Location: Wetlands Location Study

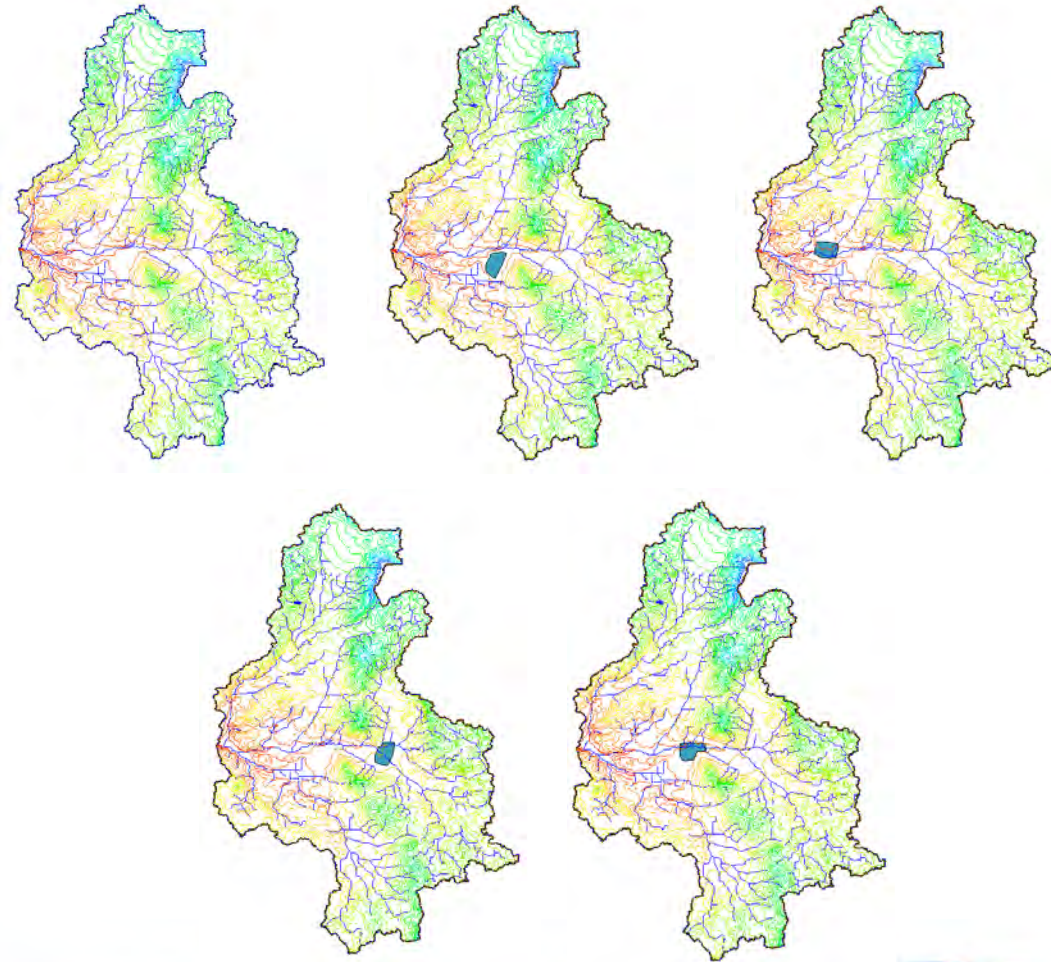

Wetlands Location Results

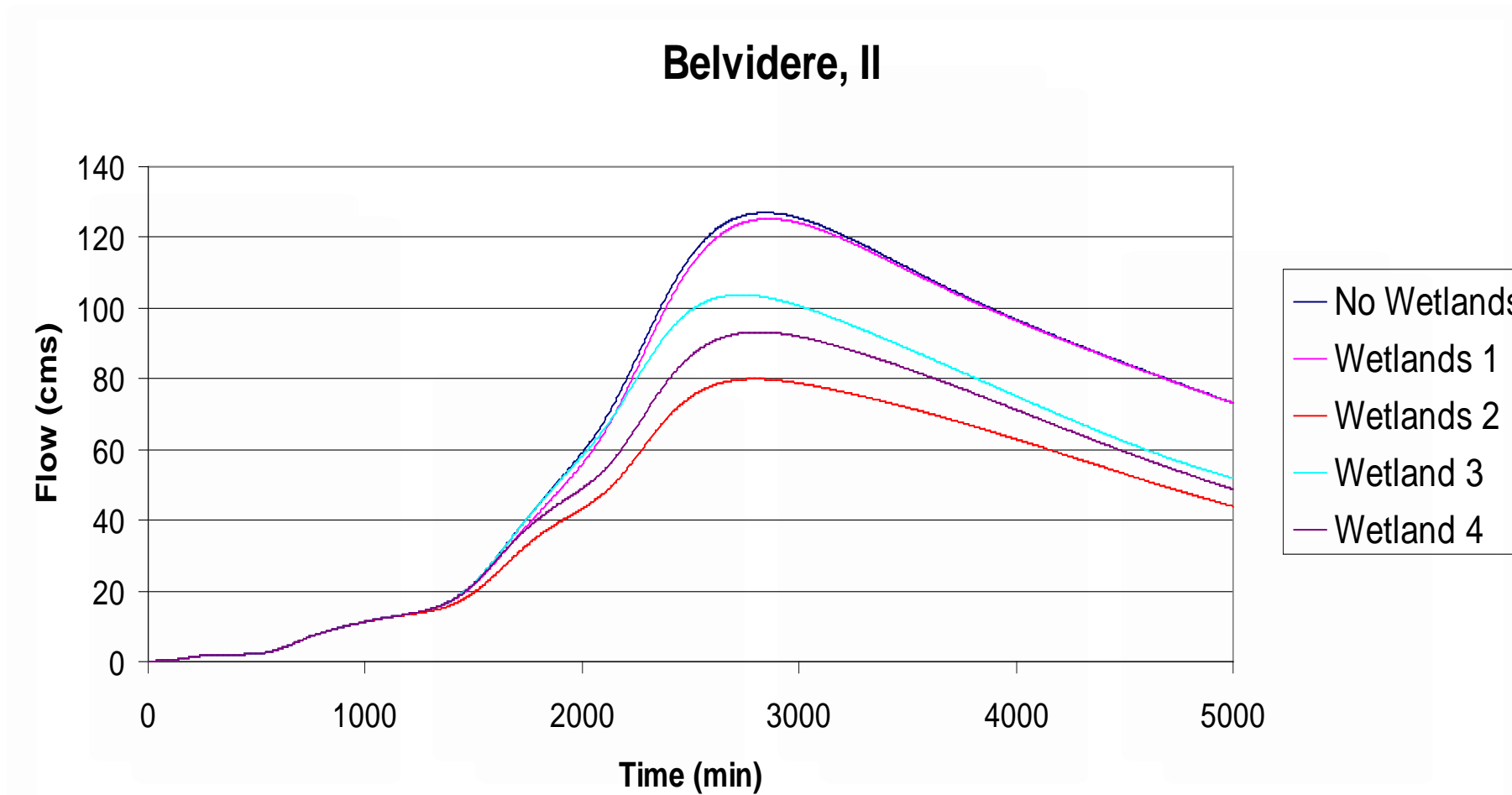

- Spatial effects of land use changes
 - *Where* you put a commercial zone, detention basin, or wetland changes the hydrology
 - Include engineered wetlands
 - Include detention basins
 - Planning and after-the-fact land use changes

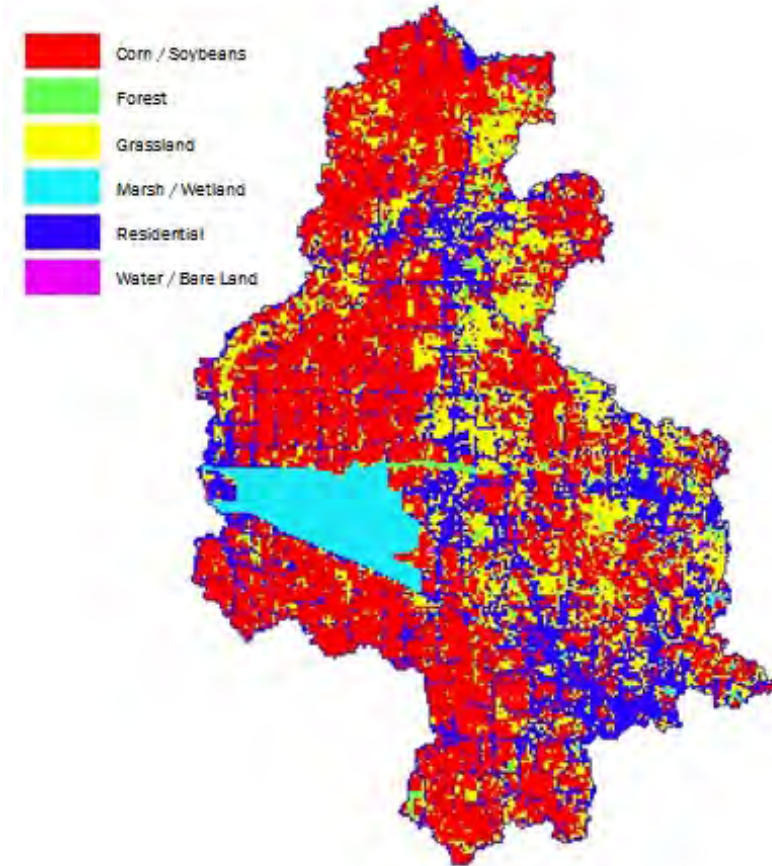
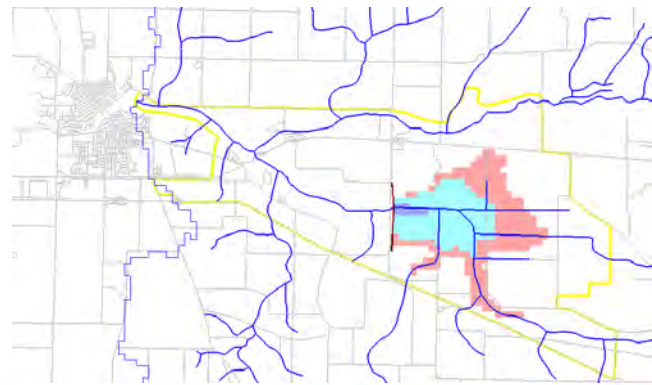

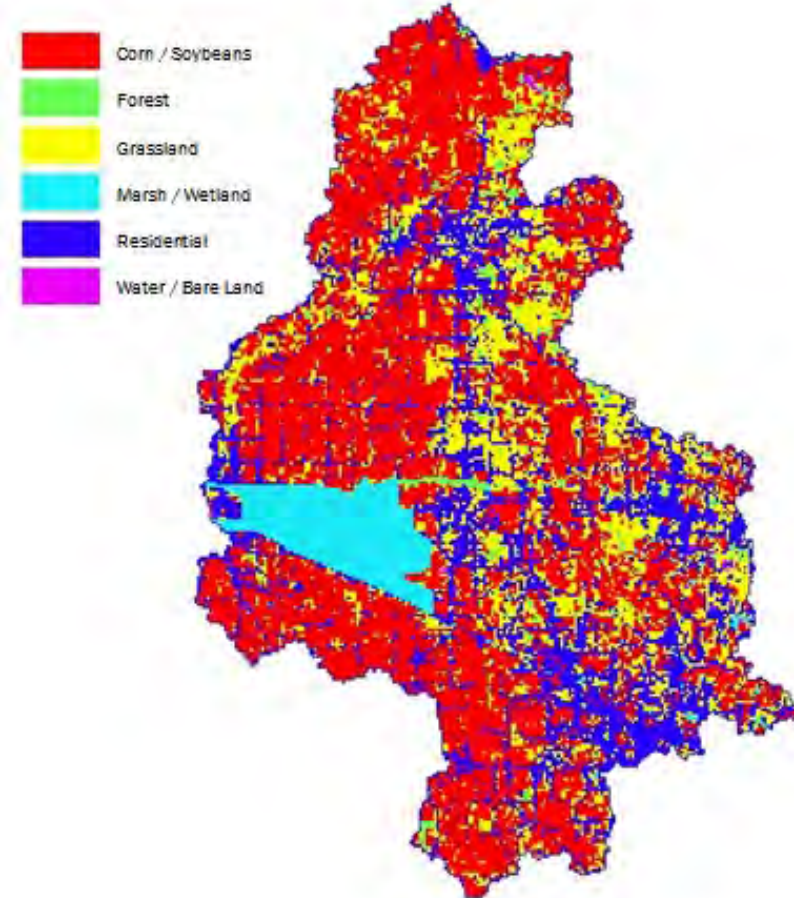
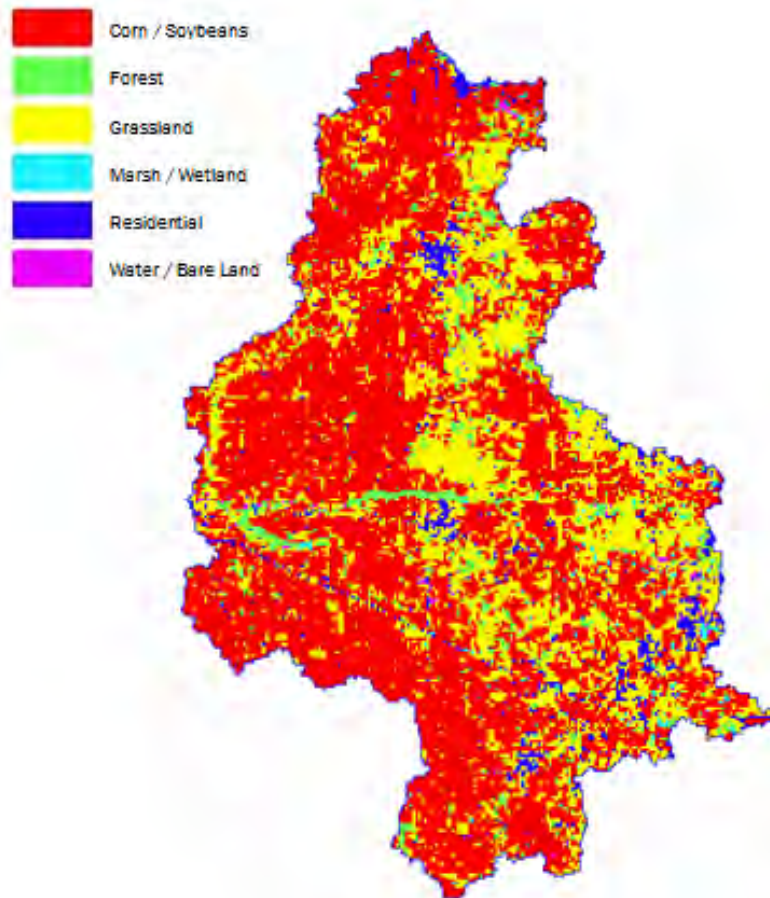

Central Kishwaukee Flooding

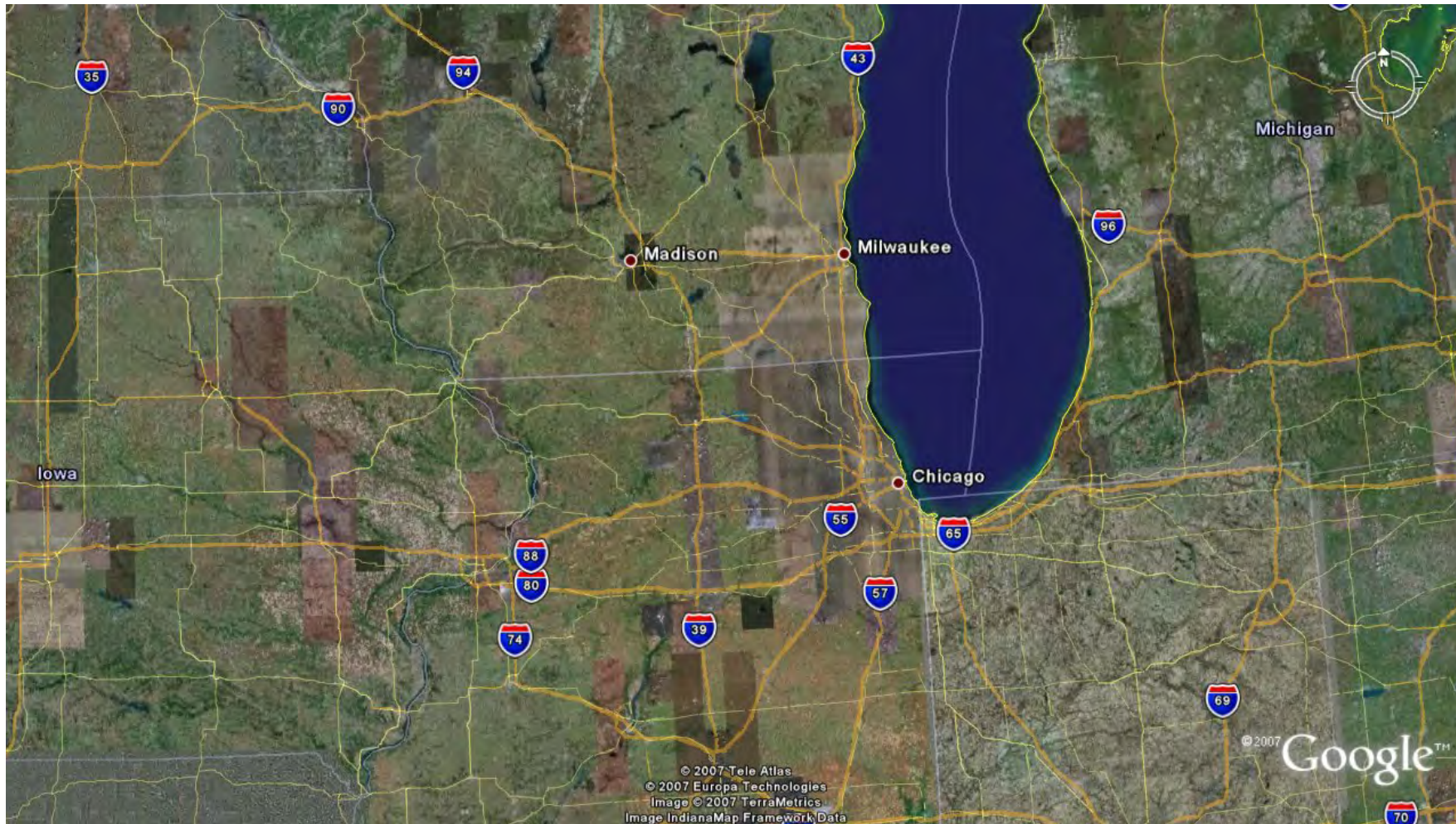

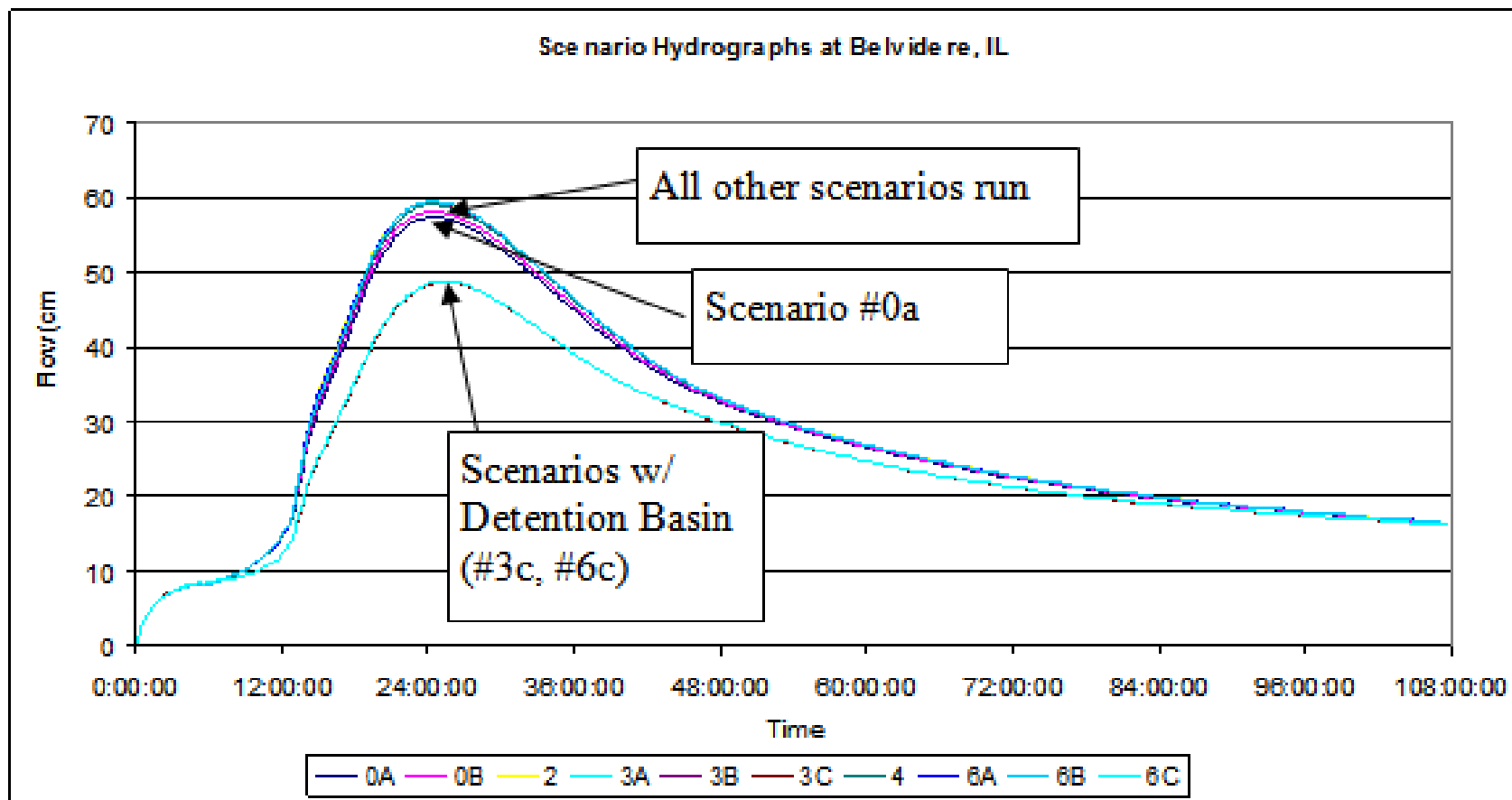

Simulation of Inland Flooding Effects

- On Saturday Oct. 27, 2012, ERDC CHL was asked by the New York District (NAN) through the UROC to provide estimates to potential flooding in the New York City area before 1200 EDT on Monday October, 29, 2012.
- Provide potential coastal storm surge estimates using the hydrodynamic model **ADCIRC**
- Provide potential inland flooding estimates using the overland flow model **GSSHA**

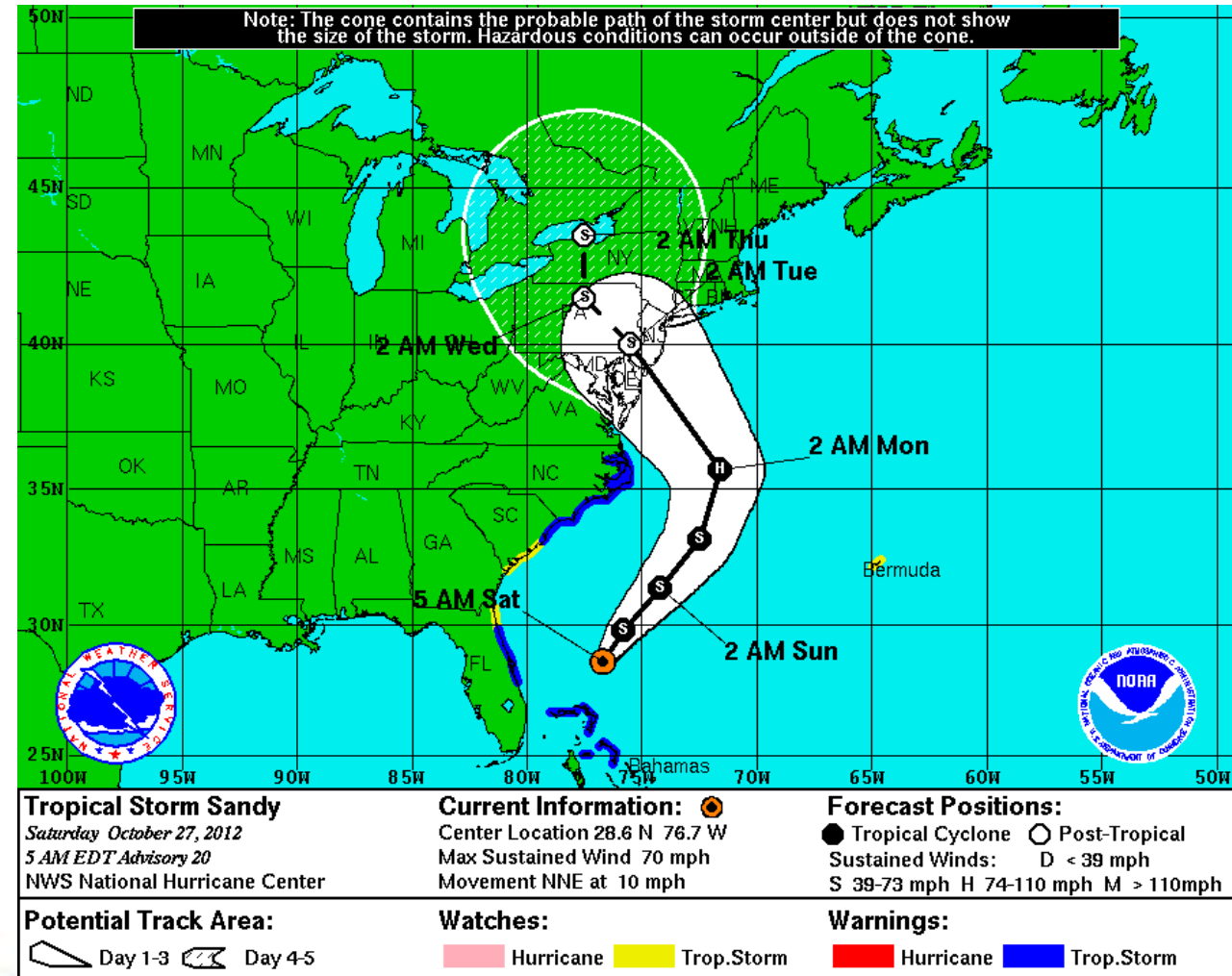

Advisory 20 from Saturday at 0500 EDT

ADCIRC Coastal Circulation and Storm Surge Model

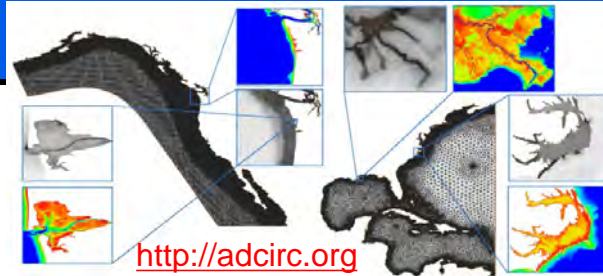

- An unstructured finite element hydrodynamics model
- 2D and 3D simulations
- Wetting/Drying algorithm allows for storm surge inundation over previously dry land
- Highly portable code
- A part of ERDC's Coastal Storm Modeling System

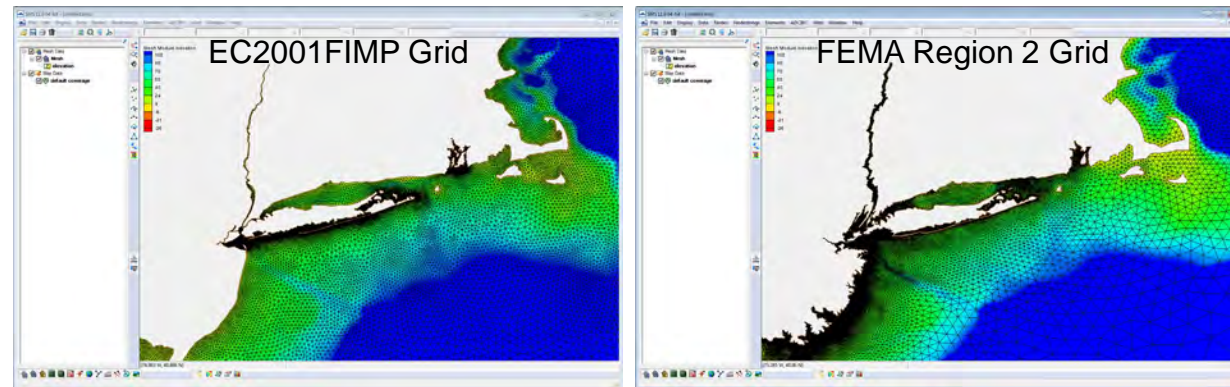

Surge Modeling for Sandy

- Used two meshes
 - EC2001FIMP Grid
 - FEMA Region 2 Grid
- Used tidal forcing and the imbedded asymmetric vortex Holland wind/pressure model
- Wind model inputs derived from the NHC forecast using the ASGS in collaboration with Dr. Jason Fleming and Dr. Rick Luettich
- Advisories 22 – 31 were simulated
- Advisory 26 results sent to NAN.

GSSHA New York Models

- GSSHA is a gridded, physics-based full hydrology model
 - Overland flow, stream flow, groundwater, vadose zone, storm and tile drains, wetlands, erosion, constituent transport
- GSSHA 2D Overland Flow Model used to predict inland flood inundation
 - Use time-varying specified head condition for storm surge
- 2 Models:
 - Central NY Model @75m (right)
 - Long Island Model @150m
- Rainfall estimated from NWS plots
- Storm surge from ADCIRC

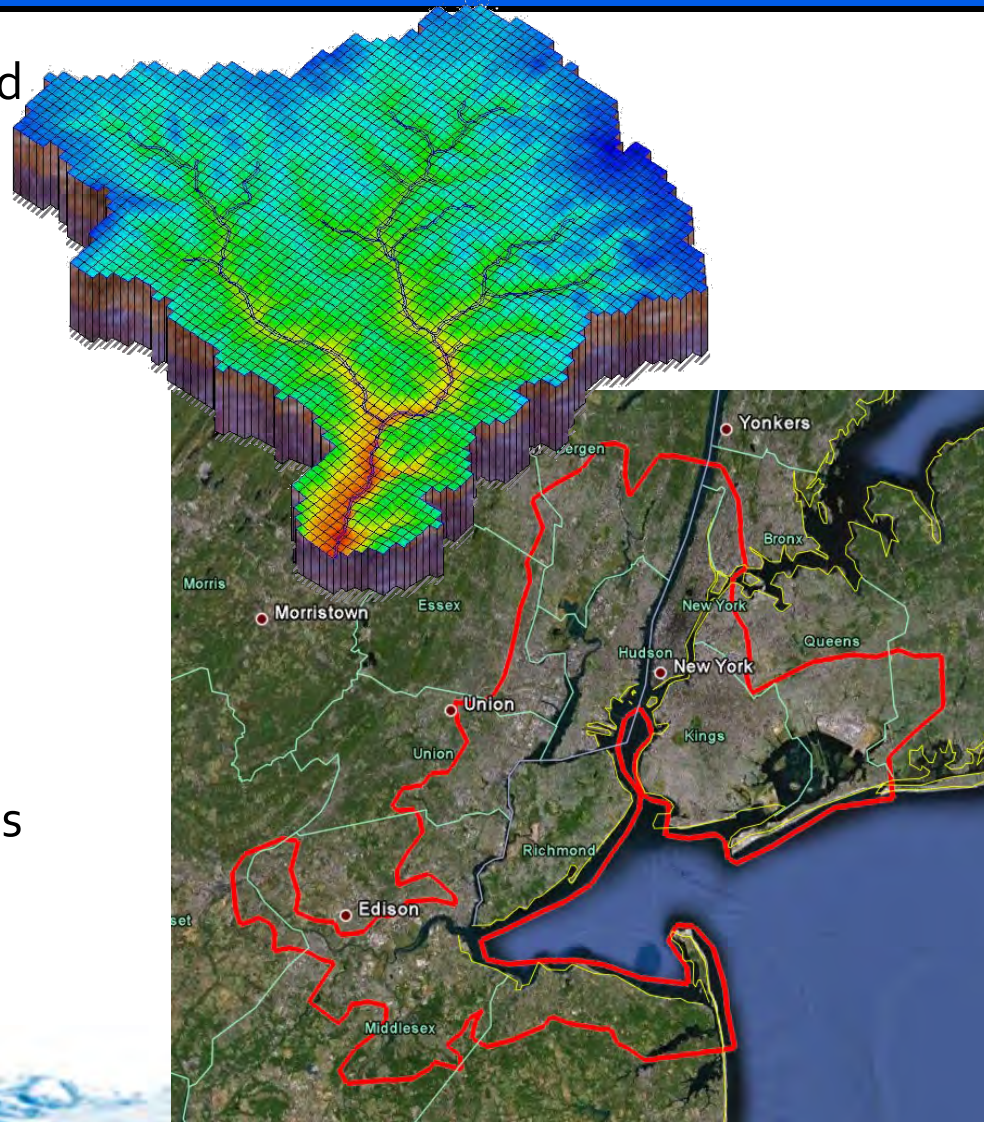

Coastal Flood Modeling – Hurricane Sandy



- GSSHA is fully distributed, physics based watershed analysis and management tool.
- It can and has been used for a variety of analysis and engineering studies.
- The spatially explicit nature of the model allows user to directly incorporate important project features into the model.
- The physical basis allows parameter values to be logically adjusted for changing conditions – land use, BMPs, climate conditions.
- The spatially explicit physics based approach offers advantages over simply models for analysis of conditions outside the range of calibration, changing, and inherently distributed processes such as sediment transport and non-point source pollution.





New Orleans

